



# EI1-60 | SINGLE & DOUBLE SWING DOOR

SHEET 006 - Fire resistance EI1-60 (in accordance with EN 1634-1)

Fire resistance

Tests carried out by the University of Liège.



All Heinen doors are constructed on the basis of the METAL+ concept, lending them superior basic performance standards.

Basic performance features of the door EI1-60:



Fire resistance (EN 1634-1)  
EI1-60



Burglary resistance (EN 1627-1630)  
RC2 subject to conditions



Acoustic performance  
Basic soundproofing:  $R_w = 30$  dB



Airtightness  
Level L1



Thermal insulation  
T4:  $Av. U 1.9$  W/m<sup>2</sup>K  
(with automatic door bottom seal)



Radiation  
EW 90



Frequency of use  
200,000 open/close cycles (max. level)  
+ durability of automatic closure: C5



Mechanical resistance  
M4 (max. level)



Service life of the door  
15-year warranty on the door set

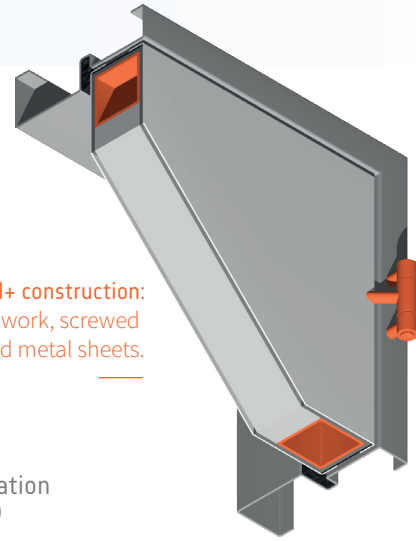

Metal+ construction:  
tubular framework, screwed  
on hinges and metal sheets.

Possible combinations: ● Burglary resistance ● Acoustic performance ● Anti-panic

## CROSS-SECTION DOOR EI1-60

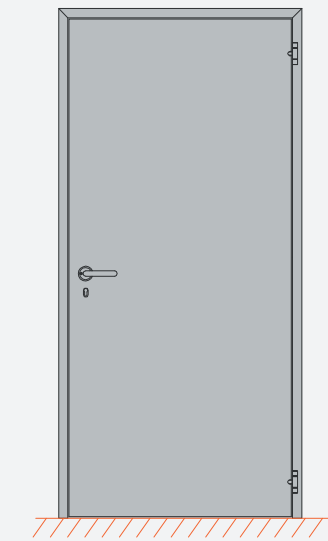

Protected side

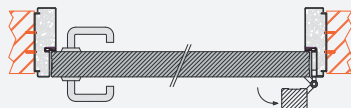

Side under attack

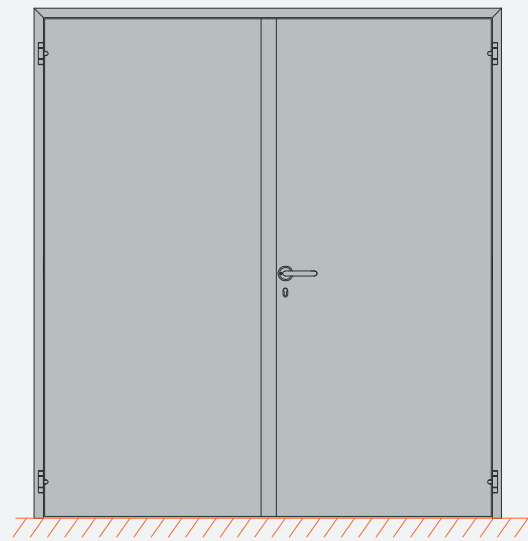

Protected side

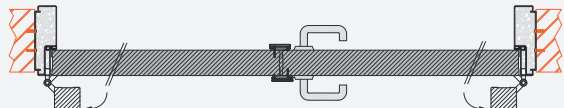

Side under attack

## DOOR DIMENSIONS *(always customised)*

### Single door

Maximum dimensions	Width	Height
Leaf	2175	4350
Opening	2285	4428
Minimum dimensions	Width	Height
Leaf	650	1479
Opening	760	1557

#### Calculation of free passage (excluding combinations) burglary resistance hinge side and non-hinge side:

FP 180° = Width of opening - 140  
 FP 90° = Width of opening - 220  
 FP = Height of opening - 90

Larger door sets are also available without a certificate.

### Double door

Maximum dimensions	Width	Height
Leaf	2175	4350
Opening	4470	4428
Minimum dimensions	Width	Height
Leaf	400	1479
Opening	920	1557

#### Calculation of free passage (excluding combinations) burglary resistance hinge side:

FP 180° = Width of opening - 140  
 FP 90° = Width of opening - 300  
 FP = Height of opening - 90

## SECURITY LOCKS *(obligatory door closer)*

### Mechanical systems

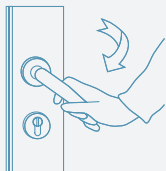

- Standard** (one point)
- Anti-panic** (1 and 3 points)
- Top and/or bottom lock**
- Security** (1 and 3 points)

### Manual locking

- Self-Security** (1 and 3 points)
- Dorma PHA 2000 + PHB 3000**
- Abloy EL 160**

### Automatic locking

### Systems with automatic locking

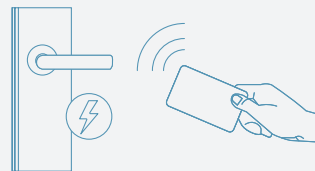

- Overlock** (in combination with Self-Security 1 or 3 points).  
Controlled entry: Fail secure.  
Free anti-panic exit or controlled exit (Fail secure).

### Solenoid locks

- EL560, 561**  
Controlled entry: Fail safe ou Fail secure.  
Free anti-panic exit or controlled exit (Fail idem entry side).

- EL518, EL520**  
Controlled entry: Fail secure.  
Free anti-panic exit or controlled exit (Fail secure).

### Motorised locks

- EL532**  
Controlled entry: Fail secure.  
Controlled exit: Fail safe.

- BB-LOCK A130+ASP**  
Lock in the frame / doorframe



Fail secure: operation by power supply.  
 Fail safe: operation by power cut.

## WINDOW CONFIGURATIONS

Solid or glazed + lateral and upper fanlights. Standard sizes or customised windows.

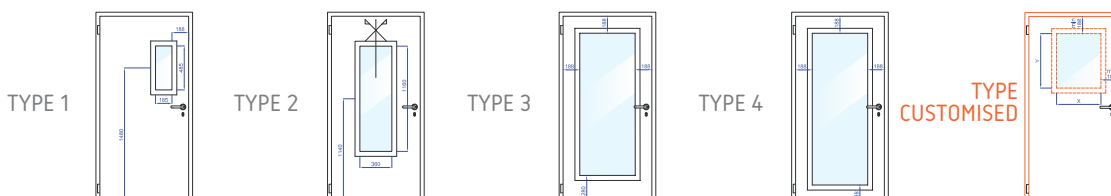

## DETAILS OF MAIN COMBINATIONS



### Burglary resistance

Tests carried out by the CNPP.  
RC2, RC3, RC4 and RC5.



### Acoustic performance

Tests carried out by the testing laboratory at the University of Liège.  
Soundproofing (Rw) up to 54 dB.  
Standard lock, double Shall-Ex, brushes.



### Anti-panic

Anti-panic bar or handle.

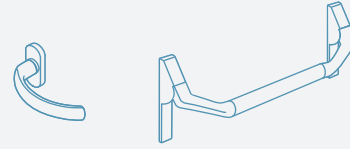

## FITTINGS

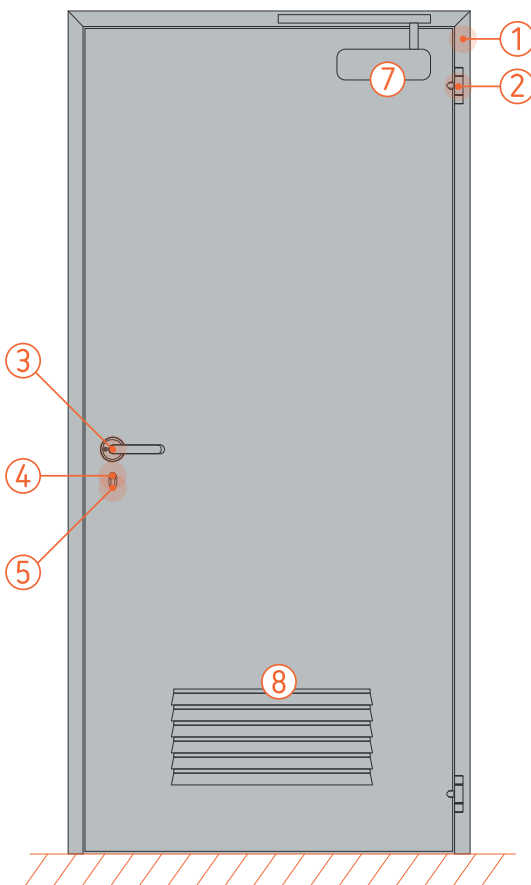

### BASIC FITTINGS

- 1 | Door frame and leaf finish**  
Hot-dip galvanised steel (275 g/m<sup>2</sup>, 20µm thick) or RAL paint.
- 2 | Hinges**  
Minimum two steel hinges, adjustable and replaceable.
- 3 | Handles**  
A set of two U-shaped aluminium handles.
- 4 | Europrofil cylinder**  
Standard.
- 5 | Backplate**  
PVC backplate.
- 6 | Lock**  
Standard 1 point.

### OPTIONAL FITTINGS

- 1 | Door frame and leaf finish**  
Stainless steel 304, 316.
- 2 | Hinges**  
One or more hinges can be added; these are always adjustable and replaceable.  
Stainless steel hinges.
- 3 | Handles**  
Handles, doorknobs, pull handles etc. in aluminium or stainless steel.
- 7 | Door closers**  
With scissor arm or sliding arm, fitting on the hinge or non-hinge side, closure selectors, open position maintained etc.
- 8 | Ventilation**  
Compliant ventilation grills for internal and external doors.  
3 standard dimensions: 3 standard dimensions.
- 9 | Security locks**  
See locks.
- 10 | Security stud system**  
Stud advised for external doors.
- 11 | Remote surveillance**  
Indication of leaf position, locking latch position, indication of leaf status.
- 12 | Various options**  
Soundproof doorsills, door stops, storm chains, impact plates and many other fittings.

## BASIC PERFORMANCES OF THE METAL+ DOOR

- **Frequency of use:**  
1,000,000 open/close cycles (maximum level)
- **Mechanical resistance:**  
M+7 (maximum level)
- **Service life of the door:**  
15-year warranty on the door set!
- **Burglary resistance:**  
RC2 (subject to conditions)
- **Acoustic performance:**  
Basic soundproofing (Rw) = 30 dB
- **Air tightness:**  
Level L1
- **Thermal insulation:**  
T4: Av. U ≈ 1.9 W/m<sup>2</sup>K (with automatic door bottom seal)

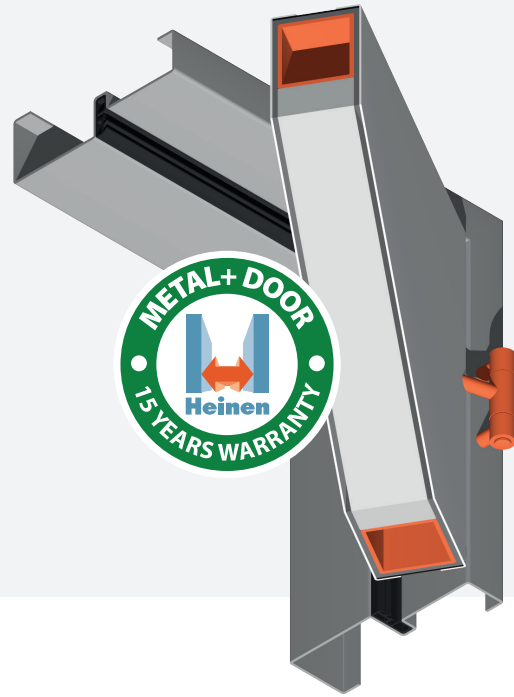

Heinen doors can combine performance features on a bespoke basis. Depending on your needs, one or more performance features are added to the basic, robust Metal+ door.



Fire resistance



Burglary resistance



Acoustic performance



Bullet-proof



Blast-proof



Electromagnetic



Anti-panic



Smoke tightness



Thermal insulation



Airtightness



Watertightness



Wind resistance



For BIM files, please consult us. Our products are certified **CE**

Heinen technical data sheet | E1-60 - single and double swing door | Sheet 006 - V01NL October  
Copyright © EuroDV 2018 | Responsible editor: Eng. Dario Dalla Valle | Non-contractual document.